

Instruction
Booklet

Electric
Oven



Important Safety Information

You **MUST** read these warnings carefully before installing or using the oven. If you need assistance, contact our Customer Care Department on **08705 950 950**.

Installation

- This oven must be installed by qualified personnel to the relevant British Standards.
- This oven is heavy. Take care when moving it.
- Remove all packaging, both inside and outside the oven, before using the oven.
- Once you have removed all packaging from the appliance, ensure that it is not damaged and the electric cable is in perfect condition. Otherwise, contact your dealer before proceeding with the installation.
- Do not attempt to modify the oven in any way.

Child Safety

- This oven is designed to be operated by adults. Do not allow children to play near or with the oven.
- Do not allow children to sit or climb on the drop down door.
- This oven is not intended for use by children or other persons whose physical, sensory or mental capabilities or lack of experience and knowledge prevents them from using the appliance safely without supervision or instruction by a responsible person to ensure that they can use the appliance safely.
- The oven gets hot when it is in use. Children should be kept away until it has cooled.

During Use

- This oven is intended for domestic cooking only. It is not designed for commercial or industrial purposes.
- The oven gets hot when it is in use and retains heat for a long period after use. Care should be taken to avoid touching heating elements inside the oven.
- Always stand back from the oven when opening the oven door during or immediately after use to allow any build up of steam to release.
- Never line any part of the oven with aluminium foil.

- Do not allow heatproof cooking material, e.g. roasting bags, to come into contact with oven elements.
- Never place plastic or any other material which may melt in or on the oven.
- Do not place sealed cans or aerosols inside the oven. They may explode if they are heated.
- Do not hang towels, dishcloths or clothes from the oven or its handle.
- Do not use this oven if it is in contact with water and never operate it with wet hands.
- Take great care when heating fats and oils as they will ignite if they become too hot.
- Always use oven gloves to remove and replace food in the oven.
- Ensure that all control knobs are in the OFF position when not in use.
- Do not leave cookware containing foodstuffs, e.g. fat or oil in or on the oven in case it is inadvertently switched ON.
- When using other electrical appliances, ensure the cable does not come into contact with the hot surfaces of the oven.

Maintenance and Cleaning

- Only clean this oven in accordance with the instructions.
- The oven should be kept clean at all times. A build-up of fats or other foodstuffs could result in a fire, especially in the grill pan.
- Always allow the oven to cool down and switch off the electrical supply before carrying out any cleaning or maintenance work.
- Never use steam or steam machines to clean the appliance.
- Do not use harsh abrasive cleaners or sharp metal scraper to clean the oven door glass since they can scratch the surface, which may result in shattering of the glass.

Contents

For the User

| | |
|-----------------------------------|----|
| Important Safety Information | 2 |
| Description of the Oven | 4 |
| Before the First Use | 4 |
| Controls | 5 |
| Electronic Programmer | 6 |
| Using the Oven | 10 |
| Hints and tips for using the Oven | 11 |
| Cleaning the Oven | 15 |
| Something not Working | 18 |
| Service and Spare Parts | 22 |
| Guarantee Conditions | 22 |
| European Guarantee | 23 |

Guide to Use the instructions

The following symbols will be found in the text to guide you throughout the Instructions:



Safety Instructions



Step by step instructions for an operation



Hints and Tips



Environmental information

Keep this instruction book for future reference and ensure it is passed on to any new owner.

For the Installer

| | |
|-----------------------|----|
| Technical Data | 19 |
| Electrical Connection | 20 |
| Building In | 21 |

Service

- This oven should only be repaired or serviced by an authorised Service Engineer and only genuine approved spare parts should be used.



Environmental Information

- After installation, please dispose of the packaging with due regard to safety and the environment.
- When disposing of an old appliance, make it unusable, by cutting off the cable. Remove any door catches, to prevent small children being trapped inside.

The symbol  on the product or on its packaging indicates that this product may not be treated as household waste. Instead it shall be handed over to the applicable collection point for the recycling of electrical and electronic equipment. By ensuring this product is disposed of correctly, you will help prevent potential negative consequences for the environment and human health, which could otherwise be caused by inappropriate waste handling of this product. For more detailed information about recycling of this product, please contact your local city office, your household waste disposal service or the shop where you purchased the product.

Description of the Oven

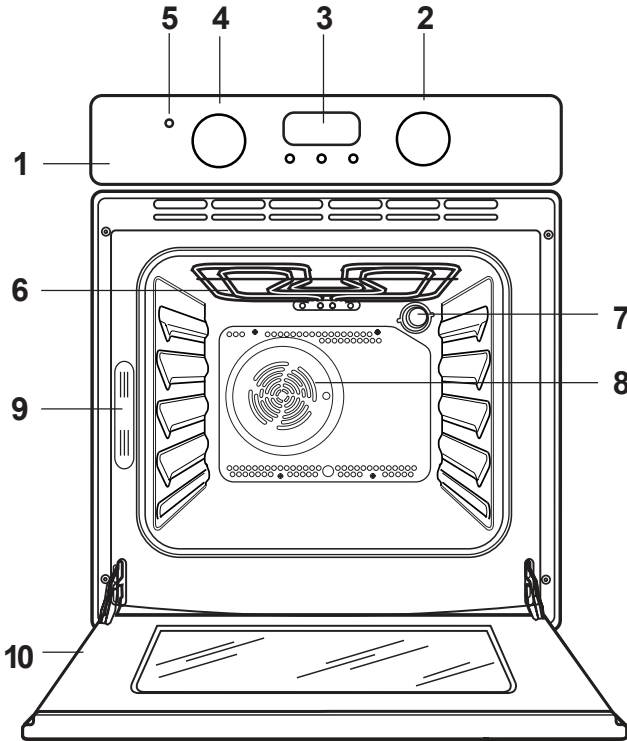

1. Control Panel
2. Oven Function Control Knob
3. Electronic Programmer
4. Thermostat Control Knob
5. Thermostat Control Light
6. Grill
7. Oven Light
8. Oven Fan
9. Rating Plate
10. Oven Door

Before the First Use



Remove **all packaging**, both inside and outside the oven, before using the appliance.

Before first use, the oven should be heated without food. During this time, an unpleasant odour may be emitted. This is quite normal.



The oven will work only if the time of day has been set.

1. Set the time of day with the electronic programmer (see chapter "Electronic Programmer").

2. Switch the oven function control knob to fan oven cooking function .

3. Set the thermostat control knob to MAX.

4. Open a window for ventilation.

5. Allow the oven to run empty for approximately 45 minutes.





This procedure should be repeated with the grill function  for approximately 5-10 minutes.



Before cooking for the first time, carefully wash the oven accessories.

Controls

Oven Function Control Knob

- 0 The oven is off.
-  **Oven Light** - The oven light will be on without any cooking function.
-  **Defrost Setting** - This setting is intended to assist in thawing of frozen food.
Ensure the thermostat control knob is in the OFF position.
-  **Fan Oven cooking** - This allows you to roast or roast and bake simultaneously using any shelf, without flavour transference.
-  **Grill** - The heat comes from the top element only.

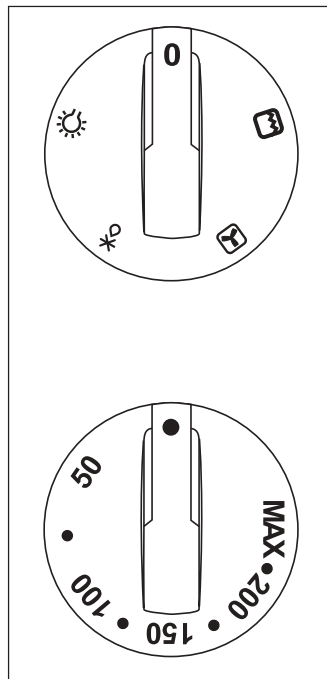

Thermostat Control Knob

Turn the thermostat control knob clockwise to select temperatures between 50°C and 230°C (MAX).

Thermostat Control Light

The thermostat control light will come on when the thermostat control knob is turned. The light will remain on until the correct temperature is reached. It will then cycle on and off to show the temperature is being maintained.

The Cooling Fan

The cooling fan is designed to cool the walls of the oven and the components of the oven itself. The fan switches on automatically after a few minutes of cooking. Warm air is blown out through the aperture near the oven door handle. When the oven is switched off, the fan will remain on in order to cool the oven and kitchen cabinets properly, after which it switches off automatically.

The Safety Thermostat

This oven is provided with a safety thermostat. In case of malfunctioning of the main thermostat, and consequent over-heating, the safety device will stop the power supply to the appliance. If this happens, call your local Service Force Centre. Under no circumstances should you attempt to repair the appliance yourself.

Electronic Programmer

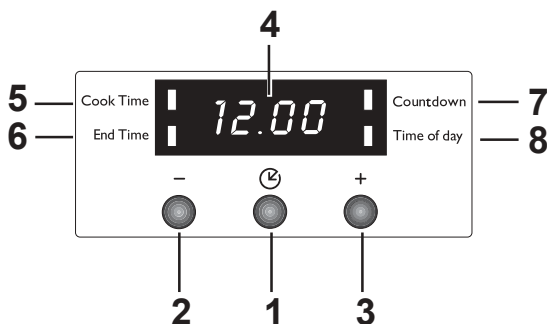

1. Control button for selecting a function
2. Decreasing control button “-”
3. Increasing control button “+”
4. Display
5. “Cook Time” pilot lamp
6. “End time” pilot lamp
7. “Countdown” pilot lamp
8. “Time of day” pilot lamp

The oven will work only if the time of day has been set. Moreover, the oven can also be operated without any programme.

In the event of a power failure, all the settings (time of day, programme setting or programme in operation) will be cancelled.

When the power is restored, the numbers in the display will flash, and the clock/timer has to be reset.

Setting the time of day

When the power supply is switched on, or after a power failure, the “Time of day” pilot lamp will flash on the display.

To set the correct time of day:

1. press button “+” or “-”.
2. After the setting is carried out, wait for 5 seconds: the “Time of day” pilot lamp will go out and the display will show the set time. The appliance is ready for use.

To reset the correct time of day:

1. press button repeatedly to select the “Time of day” function. The relevant pilot lamp will start flashing. Then proceed as described above.

The time of day can only be reset if no automatic function (cook time or end of cooking time) has been set.

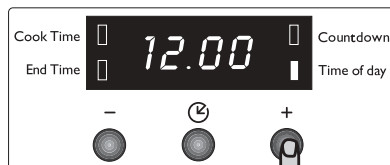

“Cook Time” function

This function allows the oven to automatically switch off at the end of a programmed cooking duration time. Place food in the oven, select a cooking function and adjust the cooking temperature.

Press button  repeatedly to select the “Cook Time” function. The relevant pilot lamp will start flashing. Then, proceed as follows:

To set the duration time:

1. press button “+” or “-”.
2. After the setting is carried out, wait for 5 seconds: the “Cook Time” pilot lamp will come on and the display will revert to the time of day.
3. When cooking time is over, the oven will be switched off automatically and an acoustic alarm will be heard, while the pilot lamp will start flashing. Turn the oven function and the thermostat control knob to zero.

To switch off the acoustic alarm, press any button. **NOTE:** when doing this operation, the oven will be operated again, therefore, remember to turn the oven function and the thermostat control knob to zero at the end of the cooking time.

To cancel the duration time:

1. Press button  repeatedly to select the “Cooking Duration” function. The relevant pilot lamp will flash and the display will show the remaining cooking time.
2. Press button “-” until the display shows “0:00”. After 5 seconds the pilot lamp will go out and the display will revert to the time of day.

“End Time” function

Thanks to this function, you can set the oven to switch off automatically when a programmed end of cooking time is over. Place food in the oven, select a cooking function and adjust the cooking temperature. Press button  repeatedly to select the “End Time” function. The relevant pilot lamp will start flashing. Then, proceed as follows:

To set the End Time:

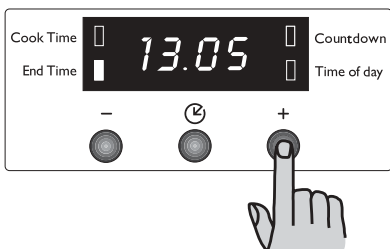
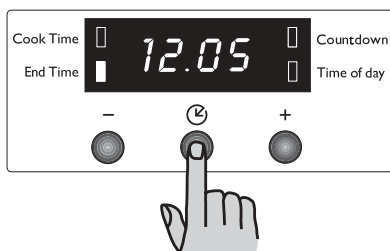
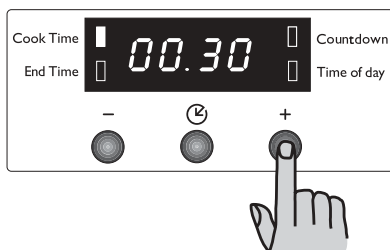
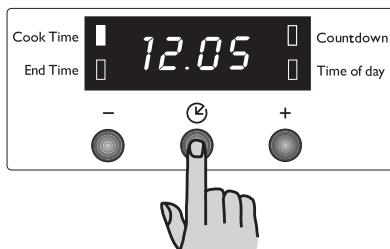

1. press button “+” or “-”.
2. After the setting is carried out, wait for 5 seconds: the “End Time” pilot lamp will come on and the display will revert to the time of day.



- When cooking time is over, the oven will be switched off automatically and an acoustic alarm will be heard, while the pilot lamp will start flashing. Turn the oven function and the thermostat control knob to zero.

To switch off the acoustic alarm, press any button. **NOTE:** when doing this operation, the oven will be operated again, therefore, remember to turn the oven function and the thermostat control knob to zero when cooking is over.

To cancel the End Time:

- Press button  repeatedly to select the “End Time” function. The relevant pilot lamp will flash and the display will show the programmed End of cooking time.
- Press button “” until the display shows the current time of day. The programmer will beep and the pilot lamp will go out.

“Cook Time” and “End Time” combined

The functions “Cook Time” and “End Time” can be used simultaneously to set the oven to switch on and off automatically at a later time.

- With the “Cook Time” function (carry out the cooking duration setting as described in the relevant chapter) set the duration time. Then, press button : the display will show the programmed setting.
- With the “End Time” function (carry out the End of cooking setting as described in the relevant chapter) set the end of cooking time.

The relevant pilot lamps will come on and the display will show the time of day. The oven will switch on and off according to the set programmes.

“Countdown” function

The countdown alarm will sound at the end of a timed period, but THE OVEN WILL REMAIN ON, if it is in use.

To set the Countdown:

1. Press button  repeatedly to select the “Countdown” function. The relevant pilot lamp will start flashing.
2. Then, press button “+” or “-” (maximum: 2 hours, 30 minutes).
3. After the setting is carried out, wait for 5 seconds: the “Countdown” pilot lamp will come on.
4. At the end of the timed period, the pilot lamp will start flashing and acoustic alarm will be heard. To switch off the acoustic alarm, press any button.

To cancel the Countdown:

1. Press button  repeatedly to select the “Countdown” function. The relevant pilot lamp will flash and the display will show the remaining time.
2. Press button “-” until the display shows “0:00”. After 5 seconds the pilot lamp will go out and the display will revert to the time of day.

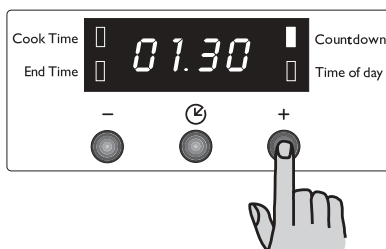
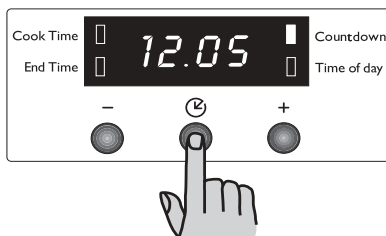

How to switch off the display

1. Press two programmer push buttons simultaneously and keep them pressed for about 5 seconds. The display will switch off.
2. To switch on the display, press any button.

The display can be switched off only if no other functions have been set.

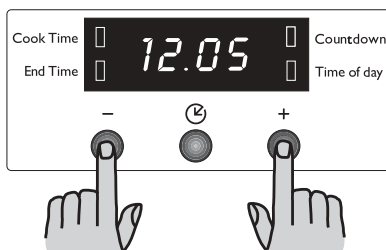

Using the Oven



Always cook with the oven door closed. Stand clear when opening the drop down oven door. **Do not** allow it to fall open - support the door using the door handle, until it is fully open. The oven has four shelf levels, and is supplied with two shelves. The shelf positions are counted from the bottom of the oven as shown in the diagram.



Attention! - Do not place cookware/objects on the oven base and do not cover any part of the oven with aluminium foil while cooking, as this could cause a heat build-up which would affect the baking results and damage the oven enamel. Always place pans, heat-resisting pans and aluminium trays on the shelf which has been inserted in the shelf runners.

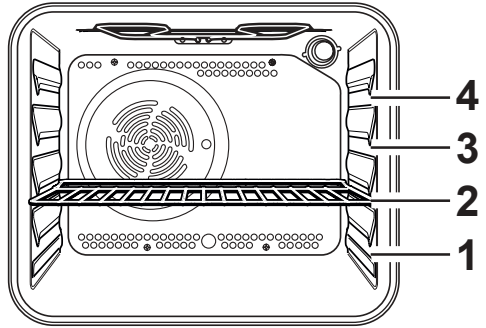

Condensation and steam

The oven is supplied with an exclusive system which produces a natural circulation of air and the constant recycling of steam. This system makes it possible to cook in a steamy environment and keep the dishes soft inside and crusty outside. Moreover, the cooking time and energy consumption are reduced to a minimum. During cooking steam may be produced which can be released when opening the oven door. This is absolutely normal.



However, always stand back from the oven when opening the oven door during cooking or at the end of it to allow any build up of steam or heat to release.



When food is heated, it produces steam in the same way as a boiling kettle does. When steam comes in contact of the oven door glass, it will condense and produce water droplets. To reduce condensation, ensure the oven is well heated before placing food in the oven cavity. A short oven pre-heating (about 10 minutes) will then be necessary before anycooking. We recommend you to wipe away condensation after each use of the appliance.

Cookware

- Use any oven proof cookware which will withstand temperatures of 230°C.
- Baking trays, oven dishes, etc. should not be placed directly against the grid covering the fan at the back of the oven, or placed on the oven base.
- Do not use baking trays larger than 30 cm x 35 cm (12 in x 14 in) as they will restrict the circulation of heat and may affect performance.

The effects of dishes on cooking results

Dishes and tins vary in their thickness, conductivity, colour, etc. which affects the way they transmit heat to the food inside them.

- A** Aluminium, earthenware, oven glassware and bright shiny utensils reduce cooking and base browning.
- B** Enamelled cast iron, anodized aluminium, aluminium with non-stick interior and coloured exterior and dark, heavy utensils increase cooking and base browning.

Hints and tips for using the Oven

Fan Oven cooking

The food is cooked by means of preheated air force blown evenly round the inside of the oven by a fan set on the rear wall of the oven itself.

Heat thus reaches all parts of the oven evenly and fast and this means that you can simultaneously cook different types of foods positioned on the various oven shelves. Fan cooking ensures rapid elimination of moisture and the dryer oven environment stops the different aromas and flavours from being transmitted from one food to another. The possibility of cooking on several shelf heights means that you can cook several different dishes at the same time and up to three tins of biscuits and mini pizzas to be eaten immediately or subsequently deep frozen. Naturally the oven can also be used for cooking on just one shelf. In this case you should use the lowest set of runners so that you can keep an eye on progress more easily. In addition, the oven is particularly recommended for sterilizing preserves, cooking home-made fruit in syrup, and for drying mushrooms or fruit.

If you wish to cook more than one dish at the same time, we suggest that you change the cooking levels of your dishes during the last 5-10 minutes in order to obtain a more uniform colour of your dishes.

NOTE: Shelf positions are counted from bottom of the oven.

Grilling

When grilling meat or fish, spread a little oil on them and always place them on the oven grid. The shelf level depends on the thickness of the food.

Always place the dripping pan at the lowest level, with some water in it, to avoid smoke and unpleasant smells.

Defrosting

The oven fan operates without heat and circulates the air, at room temperature, inside the oven. Ensure the thermostat control knob is in the OFF position.

Some hints

For baking cakes

Cakes require a moderate temperature (normally between 150°C and 200°C). In addition, the oven must be heated up beforehand - for about 10 minutes.

The oven door should not be opened before at least 3/4 of the set cooking time is up.

Normal short pastry dough should be cooked in a mould or tin for 2/3 of total cooking time required and then garnished as desired before being cooked completely.

Clearly, the remaining cooking time depends on the type of garnish used (jam, fruit, etc.). Care should be taken to ensure that any dough and cake mixes are of the right consistency since an unduly moist mix lengthens cooking time unnecessarily. The raw dough or mix should therefore be fairly difficult to detach from the spoon or beater.

If three shelves are filled with cakes and tarts simultaneously, it is advisable to slot in an extra shelf between the two lower shelves.

For cooking meat and fish

Meat cooked in the oven should weigh at least 1 kg to prevent it from becoming too dry during cooking. Very tender red meat to be cooked rare, i.e. well cooked on the outside but extremely juicy inside, requires high-temperature cooking (200°C-230°C). White meat, poultry and fish instead require low-temperature cooking (150°C-175°C).

The ingredients for the accompanying sauce or gravy should be put in the baking pan at the very beginning only when cooking times are short.

Otherwise they should be added during the last half hour. A simple way of checking whether meat is done or not is to press it with a spoon; if the meat does not yield under this pressure it means that it is done to a turn. In the case of roast beef and fillet steaks, the inside of which should remain fairly pink in color, cooking times must be short.

The meat can be cooked in a baking pan or else directly on the shelf - in this case a dripping pan must obviously be placed underneath the shelf to collect the juice.

Should you cook very fat food, place the meat directly on the grill and the grill over the dripping pan in order not to dirty the oven.

Once the meat is cooked, it is advisable to let it rest for at least 15 minutes before carving so that the juice does not seep out.

To prevent the formation of too much smoke in the oven during roasting, it is a good idea to pour a little water into the dripping pan and—to prevent steam—to add a little bit more during cooking if the original amount dries up too much.

Before serving, the various courses can be kept hot in the oven which should be turned down to the minimum temperature.

Cooking times

Cooking times vary according to the type of food to be cooked, its consistency, and volume. We suggest that you take particular note of your first cooking experiments with the oven, since operating in the same conditions for the same dishes you will of course obtain similar results. Only experience will enable you to make the appropriate changes to values given on charts.

Cooking Chart

i The oven temperatures are intended as a guide only. It may be necessary to increase or decrease the temperatures to suit individual preferences and requirements. Cooking times in the tables do not include pre-heating.

A short oven pre-heating (about 10 minutes) will then be necessary before any cooking.

If you wish to cook more than one dish at the same time, we suggest that you change the cooking levels of your dishes during the last 5-10 minutes in order to obtain a more uniform colour of your dishes.

NOTE: Shelf positions are counted from bottom of the oven.

| Food | Shelf Position | Cooking Temp (°C) |
|-------------------------|----------------|-------------------|
| Biscuits | 2 - 3 | 180-190 |
| Bread | 2 | 210-220 |
| Casseroles | 2 | 150-180 |
| Cakes: | | |
| - Small and queen | 2 | 170-180 |
| - Sponges | 2 | 180-190 |
| - Madeira | 2 | 160-170 |
| - Rich Fruit | 2 | 150-160 |
| - Christmas | 1 - 2 | 130-140 |
| - Meringues | 2 | 100-110 |
| Fish | 2 | 170-190 |
| Fruit Pies and Crumbles | 2 | 190-200 |
| Milk Puddings | 2 | 130-140 |
| Pastry: | | |
| - Choux | 2 - 3 | 160-170 |
| - Shortcrust | } 2 | 190-200 |
| - Flaky | | |
| - Puff | | |
| Plate Tarts | 1 - 2 | 190-200 |
| Quiches/Flans | 1 - 2 | 190-200 |
| Scones | 2 | 230 |
| Roasting: | | |
| - Meat & Poultry | 2 | 180-200 |

Grilling Chart

Cooking time depends on the thickness of the meat and not on its weight.

i The oven temperatures are intended as a guide only. It may be necessary to increase or decrease the temperatures to suit individual preferences and requirements.

Cooking times in the tables do not include pre-heating.



A short oven pre-heating (about 10 minutes) will then be necessary before any cooking.



Grilling must be carried out with the oven door closed. The grill pan handle must be removed from the pan during grilling.

Always use oven gloves to remove and replace the grill pan handle.

Ensure that you support the grill pan when removing it from the oven.

| TYPE OF DISH | Quantity | | Grilling | | Cooking time (minutes)  | |
|----------------------|----------|--------|---|----------|---|------------|
| | Pieces | Weight | Level  | temp. °C | Upper side | Lower side |
| Fillet steaks | 4 | 800 | 3 | max | 12 ~ 15 | 12 ~ 14 |
| Beef-steaks | 4 | 600 | 3 | max | 10 ~ 12 | 6 ~ 8 |
| Sausages | 8 | — | 3 | max | 12 ~ 15 | 10 ~ 12 |
| Pork chops | 4 | 600 | 3 | max | 12 ~ 16 | 12 ~ 14 |
| Chicken (cut in two) | 2 | 1000 | 3 | max | 30 ~ 35 | 25 ~ 30 |
| Kebabs | 4 | — | 3 | max | 10 ~ 15 | 10 ~ 12 |
| Chicken (breast) | 4 | 400 | 3 | max | 12 ~ 15 | 12 ~ 14 |
| Hamburger | 6 | 600 | 3 | max | 10 ~ 15 | 8 ~ 10 |
| Fish (fillets) | 4 | 400 | 3 | max | 12 ~ 14 | 10 ~ 12 |
| Sandwiches | 4-6 | — | 3 | max | 5 ~ 7 | — |
| Toast | 4-6 | — | 3 | max | 2 ~ 4 | 2 ~ 3 |

Cleaning the Oven



Before cleaning always allow the cooling fan to cool the cooker down before switching off at the electricity supply.

Never use steam or steam machines to clean the appliance.

The oven should be kept clean at all times. A build-up of fats or other foodstuffs could result in a fire, especially in the grill pan.

Before using any cleaning materials on your oven, check that they are suitable and that their use is recommended by the manufacturer.

Cleaners that contain bleach and harsh abrasives should **NOT** be used. For external and internal cleaning, use a soft cloth well wrung out in warm water to which a little liquid detergent has been added. To prevent damaging or weakening the door glass panels avoid the use of the following: household detergent and bleaches, impregnated pads unsuitable for non-stick saucepans, "Brillo/Ajax" pads or steel wool pads, chemical oven pads or aerosols, rust removers, bath/sink stain removers. Should the inner door glass become heavily soiled it is recommended that a cleaning product such as Hob Brite is used.



DONOT clean the oven door while the glass panels are warm. If this precaution is not observed the glass panel may shatter.

If the door glass panel becomes chipped or has deep scratches, it must be replaced to prevent the possibility of the panel shattering. Contact your local Service Force Centre.

Cleaning the Oven Door

Before cleaning the oven door, we recommend you to remove it from the oven.

Proceed as follows:

1. open the oven door completely;
2. find the hinges linking the door to the oven (**Fig. A**);
3. unlock and turn the small levers located on the two hinges (**Fig. B**);
4. handle the door by its left- and right-hand sides, then slowly turn it towards the oven until it is half-closed (**Fig. C**);
5. gently pull the oven door off its site (**Fig. C**);
6. place it on a steady plan;

Clean the oven door glass with warm soapy water and a soft cloth only. Never use harsh abrasives. Once the cleaning is carried out, refit the oven door, following the procedure in reverse.

Models in stainless steel or aluminium:

We recommend to clean the oven door using only a wet sponge and dry it up after cleaning with a soft cloth. Never use steel wool, acids or abrasive products as they can damage the oven surface. Clean the oven control panel following the same precautions.

 **DO NOT** clean the oven door while the glass panels are warm. If this precaution is not observed the glass panel may shatter.

If the door glass panel becomes chipped or has deep scratches, the glass will be weakened and must be replaced to prevent the possibility of the panel shattering. Contact your local Service Centre who will be pleased to advise further.

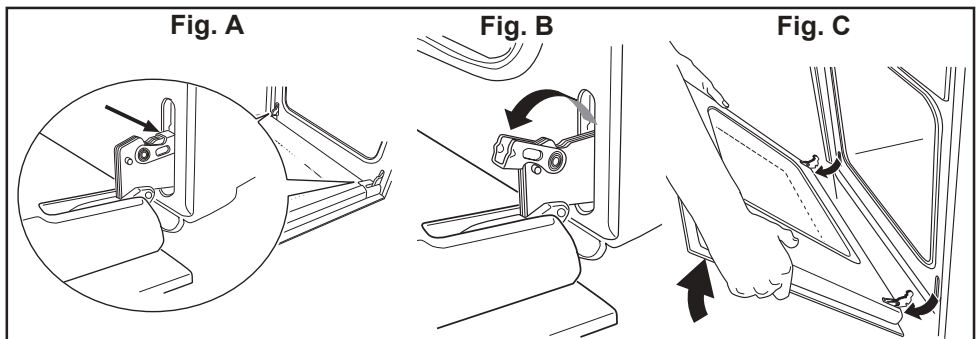

Replacing The Oven Light



Disconnect the appliance.

If the oven bulb needs replacing, it must comply with the following specifications:

Electric power: 15 W/25 W; Electric rate: 230 V (50 Hz); Resistant to temperatures of 300°C; Connection type: E14.

These bulbs are available from your local Service Force Centre. To replace the faulty bulb:

1. Ensure the oven is disconnected from the electrical supply.
2. Turn the glass cover counterclockwise.
3. Remove the faulty bulb and replace with the new one.
4. Refit the glass cover and restore the electrical supply.

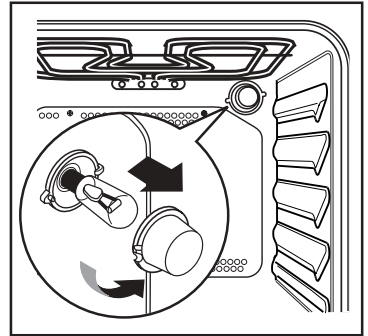

Something not Working

If the appliance is not working correctly, please carry out the following checks, before contacting your local Service Force Centre.

IMPORTANT: If you call out an engineer to a fault listed below, or to repair a fault caused by incorrect use or installation, a charge will be made even if the appliance is under guarantee.

| SYMPTOM | SOLUTION |
|---|--|
| <ul style="list-style-type: none"> ■ The oven does not come on. | <ul style="list-style-type: none"> ◆ Check that both a cooking function and temperature have been selected. ◆ Check the appliance is wired in properly, and the socket switch or the switch from the mains supply to the oven are ON. ◆ Check that the time of day has been set with the electronic programmer. |
| <ul style="list-style-type: none"> ■ The oven temperature light does not come on. | <ul style="list-style-type: none"> ◆ Select a temperature with the thermostat control knob ◆ Select a function with the oven function control knob. |
| <ul style="list-style-type: none"> ■ The oven light does not come on. | <ul style="list-style-type: none"> ◆ Select a function with the oven function control knob ◆ Check the light bulb, and replace it if necessary (see above) |
| <ul style="list-style-type: none"> ■ It takes too much time to finish the dishes, or they are cooked too fast. | <ul style="list-style-type: none"> ◆ The temperature may need adjusting ◆ Refer to the contents of this booklet, especially to the chapter "Using the Oven". |
| <ul style="list-style-type: none"> ■ Steam and condensation settle on the food and the oven cavity. | <ul style="list-style-type: none"> ◆ Leave dishes inside the oven no longer than 15-20 minutes after the cooking is completed. |
| <ul style="list-style-type: none"> ■ The oven fan is noisy. | <ul style="list-style-type: none"> ◆ Check that shelves and bakeware are not vibrating in contact with the oven back panel. |

Technical Data



The oven must be installed according to the instructions supplied.



This oven must be installed by qualified personnel.

Heating element ratings

| | |
|---------------------|---------|
| Grill element | 1,650 W |
| Fan cooking element | 2,000 W |
| Oven Fan | 25 W |
| Cooling Fan | 25 W |
| Oven Light | 25 W |
| Total Rating | 2,075 W |

Dimensions of the oven cavity

| | |
|----------------|-----------|
| Height | 335 mm |
| Width | 405 mm |
| Depth | 400 mm |
| Oven capacity: | 56 litres |

Dimensions of recess

| | |
|--------|------------------------------------|
| Height | undertop: 593 mm; in column 580 mm |
| Width | 560 ÷ 570 mm |
| Depth | 550 mm |

| | | |
|----|---|----------------------|
| 1 | Manufacturer | Moffat |
| 2 | Model | MSF 616 |
| 3 | Energy efficiency class | |
| 4 | - Conventional | |
| 5 | - Forced air convection | |
| | Energy consumption Heating function: | |
| 6 | - Conventional | |
| 7 | - Forced air convection | 0,78 kW/h |
| 8 | - Steam | |
| 9 | Usable volume (litres) | 56,0 |
| | Size: - Small - Medium - Large | |
| | Time to cook standard load: | |
| 10 | - Conventional | |
| 11 | - Forced air convection | 41 min. |
| 12 | The area of the largest baking sheet | 1130 cm ² |
| 13 | Noise (dB (A) re 1 pW) | |
| | | |
| | | |
| | <ul style="list-style-type: none"> 12 l ≤ Usable volume < 35 l 35 l ≤ Usable volume < 65 l 65 l ≤ Usable volume | |
| | | 2002/40/EC |



This appliance complies with the following **E.E.C. Directives**:

- **73/23 - 90/683** (Low Voltage Directives)
- **93/68** (General Directive);
- **89/336** (Electromagnetical Compatibility Directive)

and subsequent modifications.

Electrical Connection

The oven is designed to be connected to 230 V (50 Hz) electricity supply.

The oven has an easily accessible terminal block which is marked as follows:

Letter L - Live terminal
 Letter N - Neutral terminal
 or E - Earth terminal



THIS OVEN MUST BE EARTHED

The cable used to connect the oven to the electrical supply must comply to the specifications given below.

| Connection via | Min. size Cable/flex | Cable/flex type | Fuse |
|------------------------|----------------------|------------------------|-----------|
| 13 A socket outlet | 2.5 mm ² | 3 core butyl insulated | 13 A min. |
| 13 A spur box | | | |
| Cooker Control Circuit | 2.5 mm ² | PVC/PVC twin and earth | 13 A |

It is necessary that you install a double pole switch between the oven and the electricity supply (mains), with a minimum gap of 3mm between the switch contacts and of a type suitable for the required load in compliance with the current rules.

The switch must not break the yellow and green earth cable at any point.

the yellow and green earth cable should be 2-3 cm longer than the other cables.

Important

After installation and connecting, the cable must be placed so that it cannot at any point reach a temperature of more than 60°C above the ambient temperature.

Before the oven is connected, check that the main fuse and the domestic installation can support the load and that the power supply is properly earthed.

The manufacturer declines any responsibility should these safety measures not be carried out.

Building In

Please ensure that when the oven is installed it is easily accessible for the engineer in the event of a breakdown.

The surround or cabinet into which the oven will be built must comply with these specifications:

- the dimensions must be as shown in the relevant diagrams;
- the materials must withstand a temperature increase of at least 50°C the above temperature;
- proper arrangements must be made for a continuous supply of air to the oven to prevent the oven overheating.

Dimensions of the oven and recess required are given in the relevant diagrams.

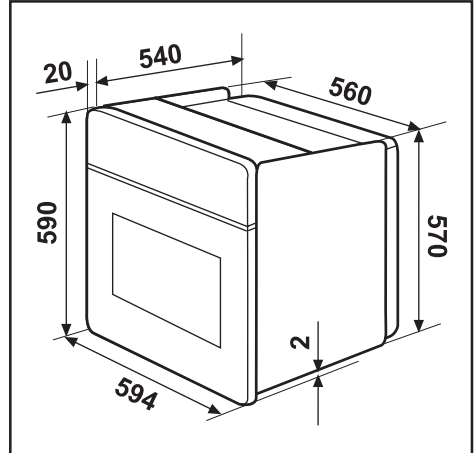

Securing The Oven To The Cabinet

1. Fit the oven into the cabinet recess.
2. Open the oven door.
3. Secure the oven to the kitchen cabinet with four wood screws, which fit the holes provided in the oven frame.

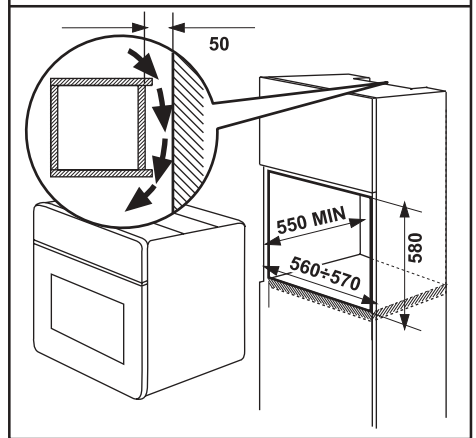
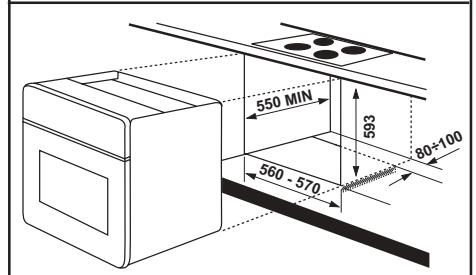
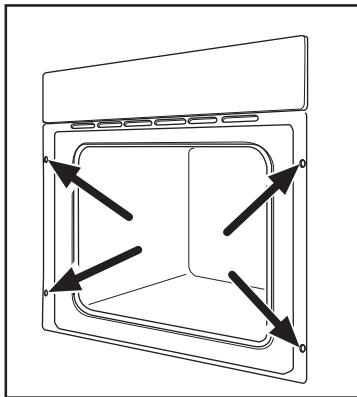

Service and Spare Parts

SERVICE FORCE

If you require spare parts or an engineer contact your local Service Force Centre by telephoning:

08705 929 929

Your call will be routed to the Service Centre covering your post code area. The addresses of Service Force Centres are detailed on the following pages.

CUSTOMERCARE

For general enquiries concerning your Moffat appliance and for further information on Moffat products, contact our Customer Care Department by letter or telephone as follows:

Customer Care Department

Moffat

55-77 High Street
Slough
Berkshire SL1 1DZ
Tel : 08705 950950

* calls to this number may be recorded for training purposes

Guarantee Conditions

Home visits are made between **8.30am and 5.30pm** Monday to Friday. Visits may be available outside these hours, in which case a **premium** will be charged.

Exclusions

This guarantee does not cover:

* Damage or calls resulting from transportation, improper use or neglect, the replacement of any light bulbs or removable parts of glass or plastic.

* Costs incurred for calls to put right an appliance which is improperly installed or calls to appliance outside the United Kingdom.

* Appliances found to be in use within a commercial or similar environment, plus those which are the subject to rental agreements.

* Products of Moffat manufacture which are not marketed by Moffat.

European Guarantee

This appliance is guaranteed by Electrolux in each of the countries listed below for the period specified in the appliance guarantee or otherwise by law. If you move from one of these countries to another of the countries listed below the appliance guarantee will move with you subject to the following qualifications:

- The appliance guarantee starts from the date you first purchased the appliance which will be evidenced by production of a valid purchase document issued by the seller of the appliance.
- The appliance guarantee is for the same period and to the same extent for labour and parts as exists in your new country of residence for this particular model or range of appliances.
- The appliance guarantee is personal to the original purchaser of the appliance and cannot be transferred to another user.
- The appliance is installed and used in accordance with instructions issued by Electrolux and is only used within the home, i.e. is not used for commercial purposes.
- The appliance is installed in accordance with all relevant regulations in force within your new country of residence.

The provisions of this European Guarantee do not affect any of the rights granted to you by law.

www.electrolux.com

|  |  |  |
|---|---|--|
| Albania | +35 5 4 261 450 | Rr. Pjeter Bogdani Nr. 7 Tirane |
| Belgique/België/Belgien | +32 2 363 04 44 | Bergensesteenweg 719, 1502 Lembeek |
| Česká republika | +420 2 61 12 61 12 | Budějovická 3, Praha 4, 140 21 |
| Danmark | +45 70 11 74 00 | Sjællandsgade 2, 7000 Fredericia |
| Deutschland | +49 180 32 26 622 | Muggenhofer Str. 135, 90429 Nürnberg |
| Eesti | +37 2 66 50 030 | Mustamäe tee 24, 10621 Tallinn |
| España | +34 902 11 63 88 | Carretera M-300, Km. 29,900 Alcalá de Henares Madrid |
| France | www.electrolux.fr | |
| Great Britain | +44 8705 929 929 | Addington Way, Luton, Bedfordshire LU4 9QQ |
| Hellas | +30 23 10 56 19 70 | 4, Limnou Str., 54627 Thessaloniki |
| Hrvatska | +385 1 63 23 338 | Slavonska avenija 3, 10000 Zagreb |
| Ireland | +353 1 40 90 753 | Longmile Road Dublin 12 |
| Italia | +39 (0) 434 558500 | C.so Lino Zanussi, 26 - 33080 Porcia (PN) |
| Latvija | +37 17 84 59 34 | Kr. Barona iela 130/2, LV-1012, Riga |
| Lituania | +370 5 27 80 609 | Verkiu 29, 09108 Vilnius, Lithuania |
| Luxembourg | +35 2 42 43 13 01 | Rue de Bitbourg, 7, L-1273 Hamm |
| Magyarország | +36 1 252 1773 | H-1142 Budapest XIV, Erzsébet királyné útja 87 |
| Nederland | +31 17 24 68 300 | Vennootsweg 1, 2404 CG - Alphen aan den Rijn |
| Norge | +47 81 5 30 222 | Risløkkvn. 2 , 0508 Oslo |
| Österreich | +43 18 66 400 | Herziggasse 9, 1230 Wien |
| Polska | +48 22 43 47 300 | ul. Kolejowa 5/7, Warsaw |
| Portugal | +35 12 14 40 39 39 | Quinta da Fonte - Edificio Gonçalves Zarco - Q 35 - 2774-518 Paço de Arcos |
| Romania | +40 21 44 42 581 | B-dul Timisoara 90, S6, Bucharest |
| Schweiz - Suisse - Svizzera | +41 62 88 99 111 | Industriestrasse 10, CH-5506 Mägenwil |
| Slovenija | +38 61 24 25 731 | Tržaška 132, 1000 Ljubljana |
| Slovensko | +421 2 43 33 43 22 | Electrolux Slovakia s.r.o., Electrolux Domáce spotrebiče SK, Seberiniho 1, 821 03 Bratislava |
| Suomi | +35 8 26 22 33 00 | Konepajanranta 4, 28100 Pori |
| Sverige | +46 (0)771 76 76 76 | Electrolux Service, S:t Göransgatan 143, S-105 45 Stockholm |
| Türkiye | +90 21 22 93 10 25 | Tarlabagi caddesi no : 35 Taksim İstanbul |
| Россия | +7 095 937 7837 | 129090 Москва, Олимпийский проспект, 16, БЦ "Олимпик" |

www.electrolux.com